

Article number: 6160401215

Description: Welding hub for taper bush type MSB
for taper bush 1215

Measures

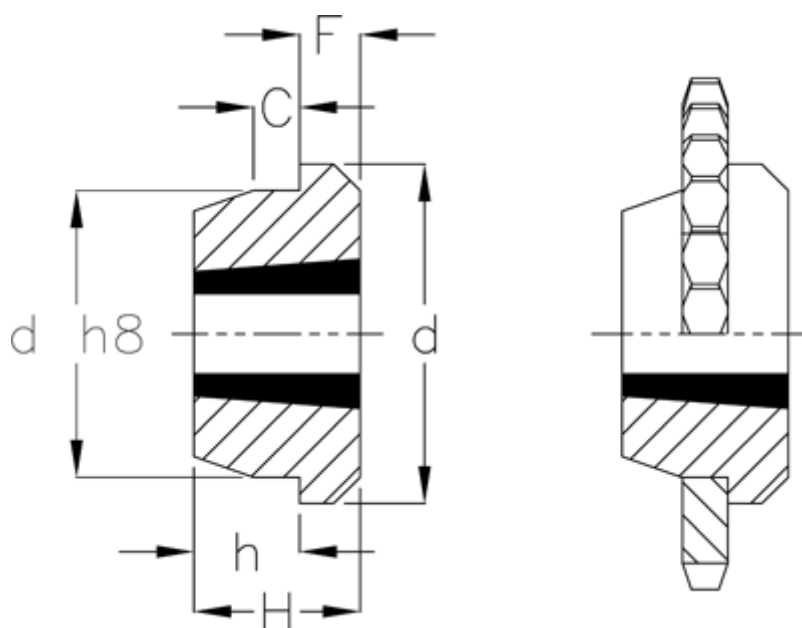

C	= 11
d	= 76
d H8	= 60
F	= 16
For taper bush = 1215	
H	= 38
h	= 22